



Hinterdreh- und Stechsystem TURNDEC

Vorteile des TURNDEC-Systems:

- Hohe Flexibilität
- Nur ein Halter für alle Operationen notwendig
- Einzigartige Wiederholgenauigkeit der Spitzenhöhe von $\pm 0,005\text{mm}$
- Hartmetall in Feinstkorn mit PVD Beschichtung neuester Generation
- Einfache Handhabung da nur eine Schraube
- extrem stabile und genaue Verbindung der Platte mit Halter



SCHELL Werkzeugsysteme GmbH
Boßlerstraße 3
D-73240 Wendlingen a. N.
Telefon: +49 7024 40898-0
Telefax: +49 7024 40898-90
e-Mail: info@schell-werkzeugsysteme.de



Halter TUHAL6 für Plattenhöhe 6mm

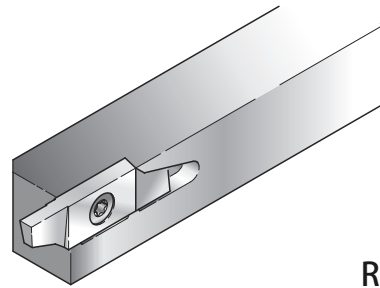

Schaftabmessung	Ausführung	Art.-Nr. L/R	Preis EUR/St.netto
7 x 7 x 110	L / R	381932 / 381933	71,00
8 x 8 x 110	L / R	378819 / 378820	71,00
10 x 10 x 120	L / R	378813 / 378816	74,00
12 x 12 x 120	L / R	378814 / 378817	74,00
16 x 16 x 120	R	404104	112,00

TORX-Ersatzteile	Typ	Art.-Nr.	EUR/St.netto
Schraube:	TP7 M2,5 x 6,5	381683	2,40
Schraubenzieher:	TP7	381682	5,00

Rohplatte unbeschichtet MG10

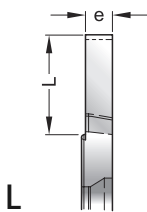

Einstecken, (Typ E6)			
Typ	e x L	Art.-Nr. links / rechts	Preis EUR/ St.netto
L / R	2,4 x 7	381634 / 381635	12,60

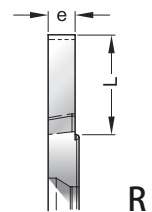

Platte beschichtet D60

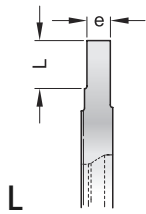

Einstechen, Drehen hinten (Typ SD6)			
Typ	e x L	Art.-Nr. links / rechts	Preis EUR/ St.netto
L / R	0,50 x 2,0	381636 / 381642	19,10
L / R	0,80 x 2,5	381637 / 381643	19,10
L / R	1,00 x 3,0	381638 / 381644	19,10
L / R	1,20 x 4,0	381639 / 381645	19,10
L / R	1,5 x 4,0	381640 / 381646	19,10
L / R	2,00 x 5,0	381641 / 381647	19,10

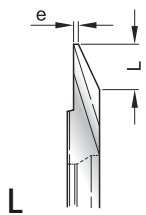
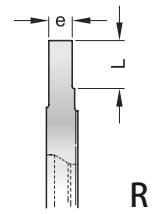

Drehen hinten (Typ D6)			
Typ	e x L	Art.-Nr. links / rechts	Preis EUR/ St.netto
L / R	0,50 x 4,0	381668 / 381669	22,10
L / R	0,50 x 4,0 r0,05	389959 / 389958	22,90
L / R	0,10 x 4,0	381670 / 381671	22,90
L / R	0,10 x 4,0 r0,05	390276 / 390277	23,60

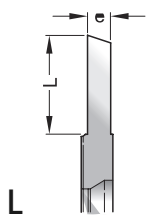
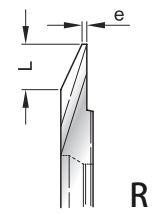

Abstechen (Typ A6)			
Typ	e x L	Art.-Nr. links / rechts	Preis EUR/ St.netto
L / R	0,50 x 1,7	381648 / 381653	19,10
L / R	0,75 x 2,7	381649 / 381654	19,10
L / R	1,00 x 3,7	381650 / 381655	19,10
L / R	1,25 x 4,7	381651 / 381656	19,10
L / R	2,00 x 6,7	381652 / 381657	19,10

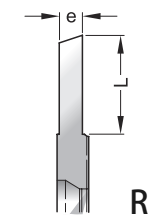

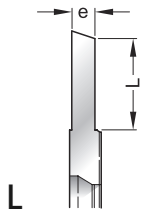

Abstechen, Gegenspindel (Typ A6c)			
Typ	e x L	Art.-Nr. links / rechts	Preis EUR/ St.netto
L / R	0,50 x 1,7	381658 / 381663	19,10
L / R	0,75 x 2,7	381659 / 381664	19,10
L / R	1,00 x 3,7	381660 / 381665	19,10
L / R	1,25 x 4,7	381661 / 381666	19,10
L / R	2,00 x 6,7	381662 / 381667	19,10

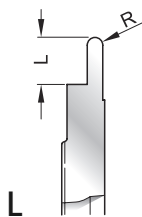
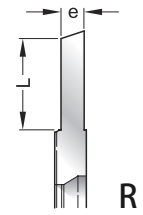

Radius (Typ R6)			
Typ	r x L	Art.-Nr. links / rechts	Preis EUR/ St.netto
L / R	0,25 x 2,0	395910 / 395900	21,00
L / R	0,50 x 3,0	395911 / 395901	21,00
L / R	0,60 x 3,0	395912 / 395902	21,00
L / R	0,75 x 4,0	395913 / 395903	21,00
L / R	0,80 x 4,0	395914 / 395904	21,00
L / R	1,00 x 5,0	395915 / 395905	21,00

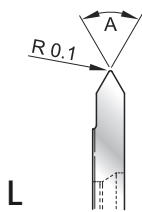
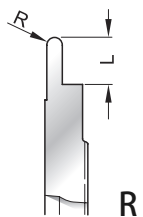

Gewinde, Teilprofil (Typ G6)			
Typ	A	Art.-Nr. links / rechts	Preis EUR/ St.netto
L / R	55°	374672 / 374674	19,80
L / R	60°	374673 / 374675	19,80

für Gewinde >= M1,6

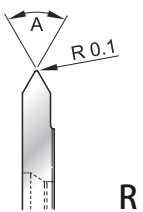

Halter TUHAL8 für Plattenhöhe 8mm

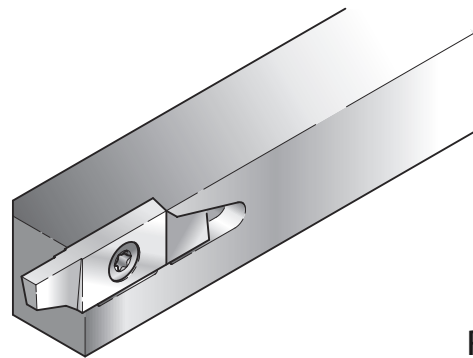

R

Schaftabmessung	Ausführung	Art.-Nr. L/R	Preis EUR/St.netto
10 x 10 x 120	L / R	374662 / 374665	74,00
12 x 12 x 120	L / R	374663 / 374666	74,00
16 x 16 x 120	L / R	374664 / 374667	78,00
20 x 20 x 120	L / R	383910 / 383790	85,00

TORX-Ersatzteile	Typ	Art.-Nr.	EUR/St.netto
Schraube:	T-15 M3,5 x 9,0	374757	2,40
Schraubenzieher:	T15	374759	5,00

Rohplatte unbeschichtet

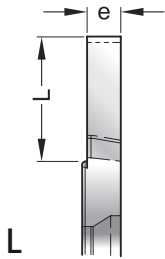

Einstecken (Typ E8)			
Typ	e x L	Art.-Nr. links / rechts	Preis EUR/ St.netto
L / R	2,95 x 11	374756 / 374755	13,30

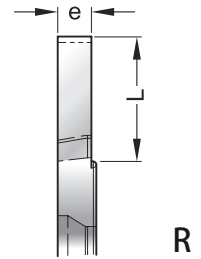

Platte beschichtet D60 (D10 auf Anfrage)

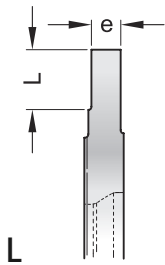

Einstecken, Drehen hinten (Typ SD8)			
Typ	e x L	Art.-Nr. links / rechts	Preis EUR/ St.netto
L / R	1,50 x 5,0	374673 / 374694	19,80
L / R	2,00 x 5,0	374672 / 374693	19,80
L / R	2,50 x 6,0	374671 / 374692	19,80

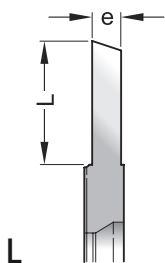
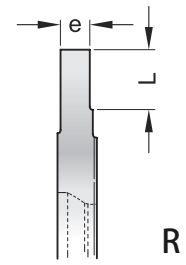

Abstechen (Typ A8)			
Typ	e x L	Art.-Nr. links / rechts	Preis EUR/ St.netto
L / R	1,50 x 8,7	374679 / 374700	19,80
L / R	2,00 x 9,7	374678 / 374699	19,80
L / R	2,50 x 10,7	374677 / 374698	19,80

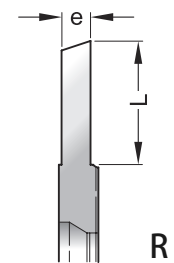

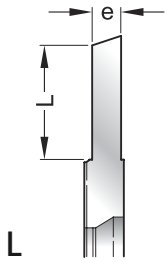

Abstechen, Gegenspindel (Typ A8C)			
Typ	e x L	Art.-Nr. links / rechts	Preis EUR/ St.netto
L / R	1,50 x 8,7	377859 / 377856	19,80
L / R	2,00 x 9,7	377858 / 377855	19,80
L / R	2,50 x 10,7	377857 / 377854	19,80

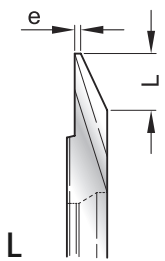
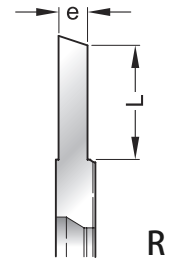

Drehen hinten (Typ D8)			
Typ	e x L	Art.-Nr. links / rechts	Preis EUR/ St.netto
L / R	0,50 x 5,0	374681 / 374702	22,90
L / R	0,50 x 5,0 r0,10	389961 / 389960	23,70
L / R	0,10 x 5,0	379666 / 377851	23,70
L / R	0,10 x 5,0 r0,10	390278 / 390279	24,50

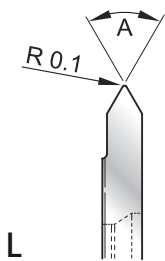
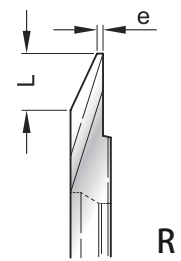

Gewinde, Teilprofil (Typ G8)			
Typ	e x L	Art.-Nr. links / rechts	Preis EUR/ St.netto
L / R	55°	374688 / 374706	21,90
L / R	60°	374687 / 374705	21,90

für Gewinde >= M4 und G1/8

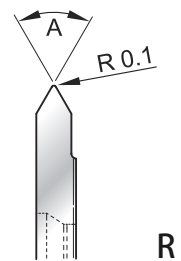

Gewinde, Vollprofil ISO metrisch	
Steigung:	
0,25 / 0,3 / 0,4 / 0,45 / 0,5 / 0,6 / 0,7 / 0,75 / 0,8 / 1,0 / 1,25 / 1,5 / 1,75	
Preis auf Anfrage	